







36 200 980

- Drehumstellung
- Rosette 60 x 60 mm



| | | |
|---|---------------------------------|---------------|
|  | Chrom | 36 200 980-00 |
|  | Platin gebürstet | 36 200 980-06 |
|  | Light Gold gebürstet | 36 200 980-27 |
|  | Messing gebürstet (23kt Gold) | 36 200 980-28 |
|  | Champagne gebürstet (22kt Gold) | 36 200 980-46 |
|  | Champagne (22kt Gold) | 36 200 980-47 |
|  | Dark Platinum gebürstet | 36 200 980-99 |

Benötigtes Zubehör



- UP-Zweiwege-Umstellung -** 35 202 970 90
- Max. Einbautiefe 160 mm
 - Min. Einbautiefe 85 mm

36 200 980

mm [inches]



Durchflussdiagramm



Zertifikate

LGA_38379.

WRAS_2307045.

36 200 980

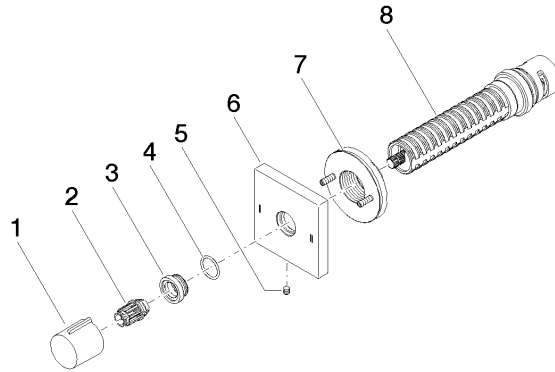

Ersatzteilstückliste

| Nr. | Artikelnummer | Benennung | Verbaumenge | Lieferzeit |
|-----|--------------------|------------|-------------|------------|
| 1 | 09 20 98 001-00 | Griff | 1 | 10 |
| 2 | 09 12 12 005 90 | Rastbuchse | 1 | 2 |
| 3 | 09 12 12 043-00 | Aufnahme | 1 | 10 |
| 4 | 09 14 10 017 90 | Dichtung | 1 | 2 |
| 5 | 09 31 11 294 90 | Stift | 1 | 2 |
| 6 | 09 27 98 037-00 | Rosette | 1 | 10 |
| 7 | 90 21 02 181 00 90 | Scheibe | 1 | 2 |
| 8 | 90 90 03 304 10 90 | Umstellung | 1 | 2 |